

Surface Mount Transient Voltage Suppressor

FEATURES

- Low profile package
- Ideal for automated placement
- Glass passivated junction
- Built-in strain relief
- Excellent clamping capability
- Fast response time: Typically less than 1.0ps from 0 volt to BV min
- Typical IR less than 1μA above 10V
- Moisture sensitivity level: level 1, per J-STD-020
- Compliant to RoHS Directive 2011/65/EU and in accordance to WEEE 2002/96/EC
- Halogen-free according to IEC 61249-2-21 definition



DO-214AB (SMC)

MECHANICAL DATA

Case: DO-214AB (SMC)

Molding compound, UL flammability classification rating 94V-0

Base P/N with suffix "G" on packing code - green compound (halogen-free)

Base P/N with prefix "H" on packing code - AEC-Q101 qualified

Terminal: Matte tin plated leads, solderable per JESD22-B102

Meet JESD 201 class 1A whisker test

with prefix "H" on packing code meet JESD 201 class 2 whisker test

Polarity: Indicated by cathode band

Weight: 0.21 g (approximately)

MAXIMUM RATINGS AND ELECTRICAL CHARACTERISTICS (T _A =25°C unless otherwise noted)			
PARAMETER	SYMBOL	VALUE	UNIT
Peak power dissipation at T _A =25°C, tp=1ms (Note 1)	P _{PK}	1500	Watts
Steady state power dissipation	P _D	5	Watts
Peak forward surge current, 8.3 ms single half sine-wave superimposed on rated load	I _{FSM}	200	A
Maximum instantaneous forward voltage at 100 A for Unidirectional only (Note 2)	V _F	3.5 / 5.0	Volts
Typical thermal resistance	R _{θJC}	10	°C/W
	R _{θJA}	55	
Operating junction temperature range	T _J	- 55 to +150	°C
Storage temperature range	T _{STG}	- 55 to +150	°C

Note 1: Non-repetitive Current Pulse Per Fig. 3 and Derated above T_A=25°C Per Fig. 2

Note 2: V_F=3.5V on SMCJ5.0 thru SMCJ90 Devices and V_F=5.0V on SMCJ100 thru SMCJ170 Devices

Devices for Bipolar Applications

1. For Bidirectional Use C or CA Suffix for Types SMCJ5.0 through Types SMCJ170
2. Electrical Characteristics Apply in Both Directions

ORDERING INFORMATION					
PART NO.	AEC-Q101 QUALIFIED	PACKING CODE	GREEN COMPOUND CODE	PACKAGE	PACKING
SMCJxxxx (Note 1)	Prefix "H"	R7	Suffix "G"	SMC	850 / 7" Plastic reel
		R6		SMC	3,000 / 13" Paper reel
		M6		SMC	3,000 / 13" Plastic reel

Note 1: "xxxx" defines voltage from 5.0V (SMCJ5.0) to 170V (SMCJ170A)

EXAMPLE					
PREFERRED P/N	PART NO.	AEC-Q101 QUALIFIED	PACKING CODE	GREEN COMPOUND	DESCRIPTION
SMCJ170A R7	SMCJ170A		R7		
SMCJ170A R7G	SMCJ170A		R7	G	Green compound
SMCJ170AHR7	SMCJ170A	H	R7		AEC-Q101 qualified

RATINGS AND CHARACTERISTICS CURVES (TA=25°C unless otherwise noted)

FIG. 1 PEAK PULSE POWER RATING CURVE

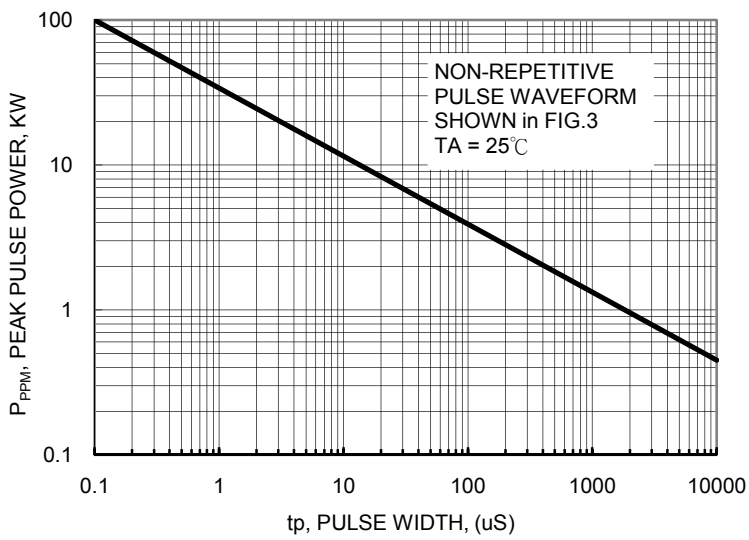

FIG.2 PULSE DERATING CURVE

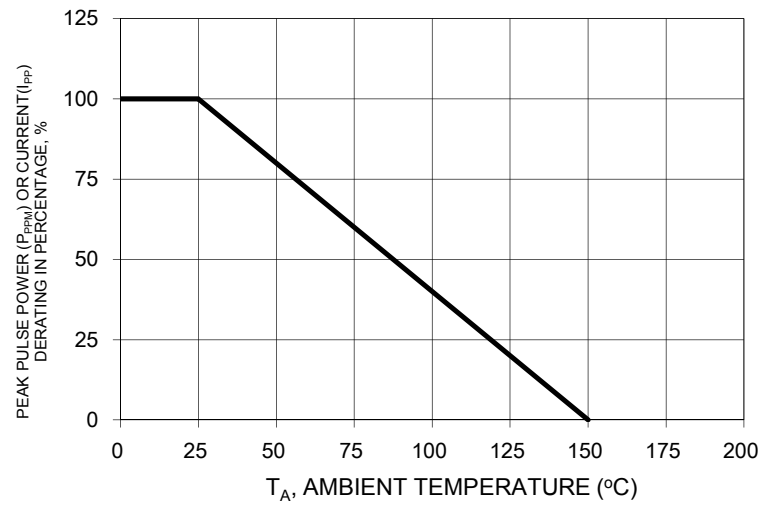

FIG. 3 CLAMPING POWER PULSE WAVEFORM

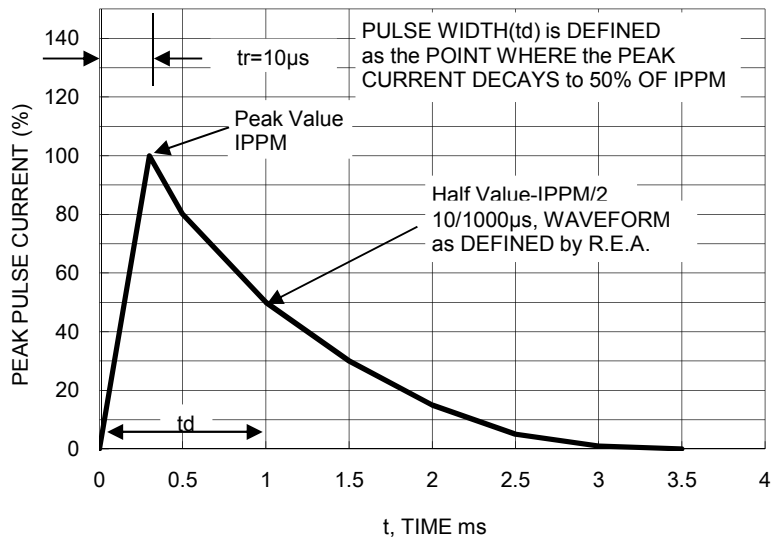

FIG. 4 MAXIMUM NON-REPETITIVE FORWARD SURGE CURRENT

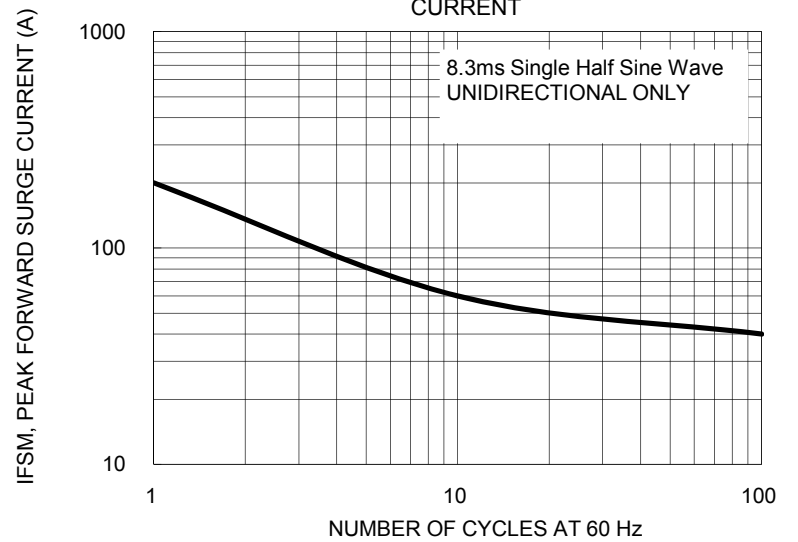
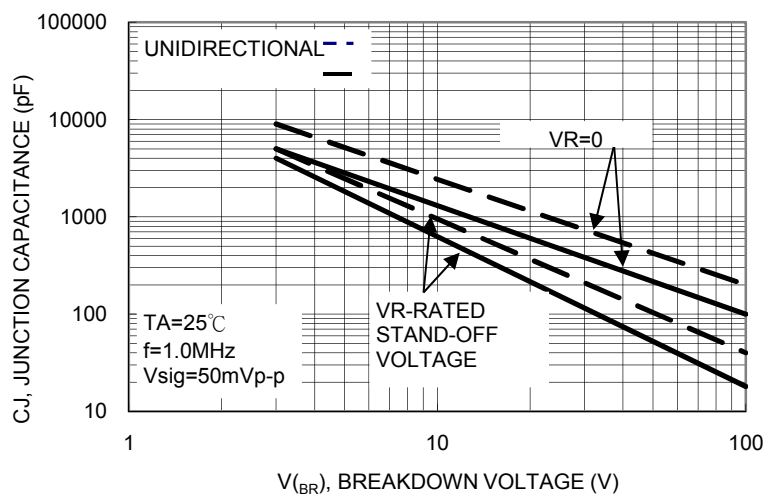

FIG. 5 TYPICAL JUNCTION CAPACITANCE



Device	Device Marking Code	Breakdown Voltage VBR (V) at I _T		Test Current I _T (mA)	Stand-Off Voltage V _{WM} (V)	Maximum Reverse Leakage @ V _{WM} I _D (uA) (Note3)	Maximum Peak Surge Current I _{PPM} (A) (Note2)	Maximum Clamping Voltage at IPPM V _c (V) (Note5)
		Min	Max					
SMCJ5.0	GDD	6.4	7.3	10	5	1000	164	9.6
SMCJ5.0A	GDE	6.4	7	10	5	1000	171	9.2
SMCJ6.0	GDF	6.67	8.15	10	6	1000	138	11.4
SMCJ6.0A	GDG	6.67	7.37	10	6	1000	152	10.3
SMCJ6.5	GDH	7.22	8.82	10	6.5	500	128	12.3
SMCJ6.5A	GDK	7.22	7.98	10	6.5	500	140	11.2
SMCJ7.0	GDL	7.78	9.51	10	7	200	118	13.3
SMCJ7.0A	GDM	7.78	8.6	10	7	200	131	12.0
SMCJ7.5	GDN	8.33	10.30	1	7.5	100	110	14.3
SMCJ7.5A	GDP	8.33	9.21	1	7.5	100	122	12.9
SMCJ8.0	GDQ	8.89	10.9	1	8	50	105	15.0
SMCJ8.0A	GDR	8.89	9.83	1	8	50	115	13.6
SMCJ8.5	GDS	9.44	11.5	1	8.5	20	99	15.9
SMCJ8.5A	GDT	9.44	10.4	1	8.5	20	109	14.4
SMCJ9.0	GDU	10	12.2	1	9	10	93	16.9
SMCJ9.0A	GDV	10	11.1	1	9	10	102	15.4
SMCJ10	GDW	11.1	13.6	1	10	5	83	18.8
SMCJ10A	GDX	11.1	12.3	1	10	5	92	17.0
SMCJ11	GDY	12.2	14.9	1	11	1	78	20.1
SMCJ11A	GDZ	12.2	13.5	1	11	1	86	18.2
SMCJ12	GED	13.3	16.3	1	12	1	71	22.0
SMCJ12A	GEE	13.3	14.7	1	12	1	79	19.9
SMCJ13	GEF	14.4	17.6	1	13	1	66	23.8
SMCJ13A	GEG	14.4	15.9	1	13	1	73	21.5
SMCJ14	GEH	15.6	19.1	1	14	1	61	25.8
SMCJ14A	GEK	15.6	17.2	1	14	1	67	23.2
SMCJ15	GEL	16.7	20.4	1	15	1	58	26.9
SMCJ15A	GEM	16.7	18.5	1	15	1	64	24.4
SMCJ16	GEN	17.8	21.8	1	16	1	54	28.8
SMCJ16A	GEP	17.8	19.7	1	16	1	60	26.0
SMCJ17	GEQ	18.9	23.1	1	17	1	51	30.5
SMCJ17A	GER	18.9	20.9	1	17	1	57	27.6
SMCJ18	GES	20	24.4	1	18	1	48	32.2
SMCJ18A	GET	20	22.1	1	18	1	53	29.2
SMCJ20	GEU	22.2	27.1	1	20	1	43	35.8
SMCJ20A	GEV	22.2	24.5	1	20	1	48	32.4
SMCJ22	GEW	24.4	29.8	1	22	1	39	39.4
SMCJ22A	GEX	24.4	26.9	1	22	1	44	35.5
SMCJ24	GEY	26.7	32.6	1	24	1	36	43.0
SMCJ24A	GEZ	26.7	29.5	1	24	1	40	38.9
SMCJ26	GFD	28.9	35.3	1	26	1	33	46.6
SMCJ26A	GFE	28.9	31.9	1	26	1	37	42.1
SMCJ28	GFF	31.1	38	1	28	1	31	50.0
SMCJ28A	GFG	31.1	34.4	1	28	1	34	45.4
SMCJ30	GFH	33.3	40.7	1	30	1	29	53.5
SMCJ30A	GFK	33.3	36.8	1	30	1	32	48.4
SMCJ33	GFL	36.7	44.9	1	33	1	26	59.0
SMCJ33A	GFM	36.7	40.6	1	33	1	29	53.3
SMCJ36	GFN	40	48.9	1	36	1	24	64.3
SMCJ36A	GFP	40	44.2	1	36	1	27	58.1

Device	Device Marking Code	Breakdown Voltage VBR (V) at I _T		Test Current I _T (mA)	Stand-Off Voltage V _{WM} (V)	Maximum Reverse Leakage @ V _{WM} I _D (uA) (Note3)	Maximum Peak Surge Current I _{PPM} (A) (Note2)	Maximum Clamping Voltage at IPPM V _c (V) (Note5)
		Min	Max					
SMCJ40	GFQ	44.4	54.3	1	40	1	22	71.4
SMCJ40A	GFR	44.4	49.1	1	40	1	24	64.5
SMCJ43	GFS	47.8	58.4	1	43	1	20	76.7
SMCJ43A	GFT	47.8	52.8	1	43	1	22	69.4
SMCJ45	GFU	50	61.1	1	45	1	19	80.3
SMCJ45A	GFV	50	55.3	1	45	1	21	72.7
SMCJ48	GFW	53.3	65.1	1	48	1	18	85.5
SMCJ48A	GFX	53.3	58.9	1	48	1	20	77.4
SMCJ51	GFY	56.7	69.3	1	51	1	17	91.1
SMCJ51A	GFZ	56.7	62.7	1	51	1	19	82.4
SMCJ54	GGD	60	73.3	1	54	1	16	96.3
SMCJ54A	GGE	60	66.3	1	54	1	18	87.1
SMCJ58	GGF	64.4	78.7	1	58	1	15	103
SMCJ58A	GGG	64.4	71.2	1	58	1	16	93.6
SMCJ60	GGH	66.7	81.5	1	60	1	14	107
SMCJ60A	GGK	66.7	73.7	1	60	1	16	96.8
SMCJ64	GGL	71.1	86.9	1	64	1	13.8	114
SMCJ64A	GGM	71.1	78.6	1	64	1	15	103
SMCJ70	GGN	77.8	95.1	1	70	1	12.6	125
SMCJ70A	GGP	77.8	86	1	70	1	13.9	113
SMCJ75	GGQ	83.3	102	1	75	1	11.7	134
SMCJ75A	GGR	83.3	92.1	1	75	1	13	121
SMCJ78	GGS	86.7	106	1	78	1	11.3	139
SMCJ78A	GGT	86.7	95.8	1	78	1	12.5	126
SMCJ85	GGU	94.4	115	1	85	1	10.4	151
SMCJ85A	GGV	94.4	104	1	85	1	11.5	137
SMCJ90	GGW	100	122	1	90	1	9.8	160
SMCJ90A	GGX	100	111	1	90	1	10.7	146
SMCJ100	GGY	111	136	1	100	1	8.8	179
SMCJ100A	GGZ	111	123	1	100	1	9.7	162
SMCJ110	GHD	122	149	1	110	1	8	196
SMCJ110A	GHE	122	135	1	110	1	8.9	177
SMCJ120	GHF	133	163	1	120	1	7.3	214
SMCJ120A	GHG	133	147	1	120	1	8.1	193
SMCJ130	GHH	144	176	1	130	1	6.8	231
SMCJ130A	GHK	144	159	1	130	1	7.5	209
SMCJ150	GHL	167	204	1	150	1	5.8	266
SMCJ150A	GHM	167	185	1	150	1	6.4	243
SMCJ160	GHN	178	218	1	160	1	5.4	287
SMCJ160A	GHP	178	197	1	160	1	6	259
SMCJ170	GHQ	189	231	1	170	1	5.1	304
SMCJ170A	GHR	189	209	1	170	1	5.7	275

Notes:

1. V_{BR} measure after I_T applied for 300us, I_T=square wave pulse or equivalent.
2. Surge current waveform per Figure. 3 and derate per Figure. 2.
3. For bipolar types having V_{WM} of 10 volts and less, the I_D limit is doubled.
4. All terms and symbols are consistent with ANSI/IEEE C62.35.

PACKAGE OUTLINE DIMENSIONS

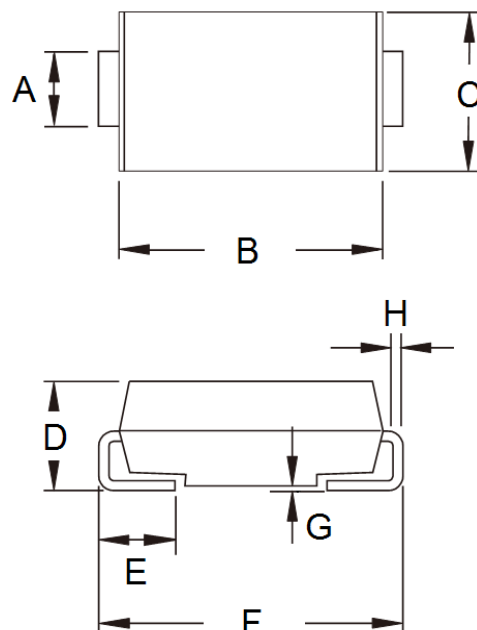

DIM.	Unit (mm)		Unit (inch)	
	Min	Max	Min	Max
A	2.90	3.20	0.114	0.126
B	6.60	7.11	0.260	0.280
C	5.59	6.22	0.220	0.245
D	2.00	2.62	0.079	0.103
E	1.00	1.60	0.039	0.063
F	7.75	8.13	0.305	0.320
G	0.10	0.20	0.004	0.008
H	0.15	0.31	0.006	0.012

SUGGESTED PAD LAYOUT

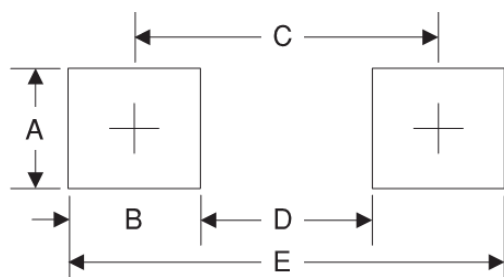

Symbol	Unit (mm)	Unit (inch)
A	3.3	0.130
B	2.5	0.098
C	6.8	0.268
D	4.4	0.173
E	9.4	0.370

MARKING DIAGRAM



- P/N = Specific Device Code
- G = Green Compound
- YW = Date Code
- F = Factory Code

Notice

Specifications of the products displayed herein are subject to change without notice. TSC or anyone on its behalf, assumes no responsibility or liability for any errors inaccuracies.

Information contained herein is intended to provide a product description only. No license, express or implied, to any intellectual property rights is granted by this document. Except as provided in TSC's terms and conditions of sale for such products, TSC assumes no liability whatsoever, and disclaims any express or implied warranty, relating to sale and/or use of TSC products including liability or warranties relating to fitness for a particular purpose, merchantability, or infringement of any patent, copyright, or other intellectual property right.

The products shown herein are not designed for use in medical, life-saving, or life-sustaining applications. Customers using or selling these products for use in such applications do so at their own risk and agree to fully indemnify TSC for any damages resulting from such improper use or sale.